



YARDWORKS^{®/MD}

13" (33 CM) CORDLESS GRASS TRIMMER

model number 060-1983-0 | contact us: 1.866.523.5218



Intertek
3026035

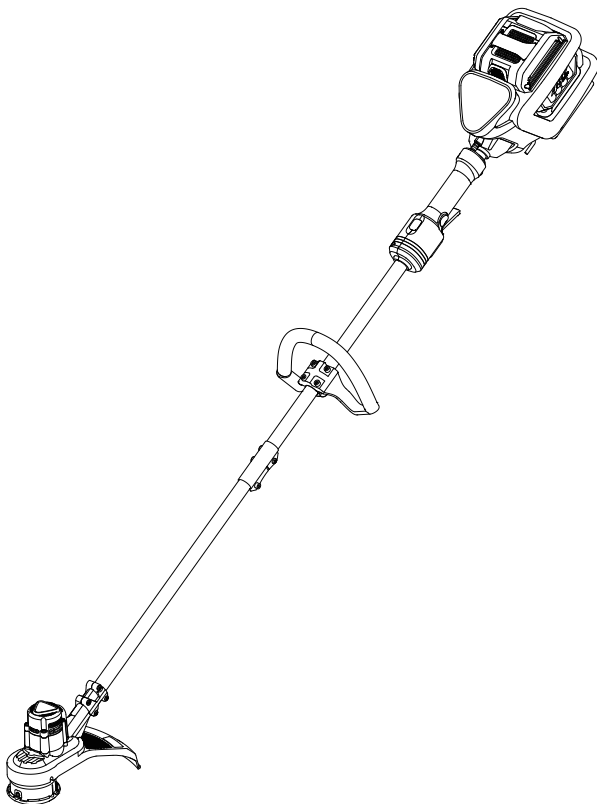

IMPORTANT:

Read and follow all safety rules and operating instructions before using this product.

**Instruction
Manual**



For problems or questions, **DO**
NOT RETURN TO STORE. Please
contact one of our Customer
Service Agents who would be
happy to assist you.

For Customer Assistance Please Call:



CANADA: 1.866.523.5218

Introduction	4
Safety Instructions and Symbols	5
Product Specifications	9
Product Diagram	10
Assembly	11
Operation	12
Maintenance	18
Storage	18
Troubleshooting	19
Exploded View	20
Parts List	21
Warranty	22



Please do not operate garden equipment near children. This could lead to severe injury or death.

INTRODUCTION

Congratulations on your purchase of your new Yardworks® tool. It has been designed, engineered and manufactured to give you the best possible dependability and performance.

Should you experience any problem you cannot easily remedy, please contact our Yardworks® customer service line at 1.866.523.5218.

PLEASE READ AND RETAIN THIS INSTRUCTION MANUAL. These instructions will enable you to assemble and maintain your appliance properly. **ALWAYS** observe the “SAFETY RULES”.

The instruction manual was designed to conveniently help you get your purchase ready to use so there's less risk of damaging it and to provide you with enough information for you to get familiar with your product's controls and features and to operate it safely.

SAFETY FIRST



CAUTION: The operation of lawn equipment can result in foreign objects thrown into the eyes, which can result in SEVERE EYE INJURY. ALWAYS wear safety glasses or eye shields while operating your lawn equipment or performing any adjustments or repairs. We recommend standard safety glasses or a wide vision safety mask worn over spectacles.



Please read this manual carefully and make sure you understand the instructions before using the machine.

Model number: _____

Serial number: _____

Date of purchase (MM/DD/YYYY): _____

Notes: _____

FOR ALL APPLIANCES

- Avoid dangerous environments — do not use appliances in damp or wet locations.
- Don't use in rain.
- Keep children away — all people and pets should be kept at a distance from the work area.
- Dress properly — do not wear loose clothing or jewellery. They can be caught in moving parts. Wear protective clothing; use of work gloves, long pants, a long-sleeved shirt and safety footwear is recommended when working outdoors. Wear protective hair covering to contain long hair.
- Use safety glasses — always use face or dust mask if the area in which you are working is dusty.
- Use the right appliance — do not use appliance for any job except that for which it is intended.
- Do not force appliance — it will do the job better and with less likelihood of a risk of injury at the rate for which it was designed.
- Do not overreach — keep proper footing and balance at all times.
- Stay alert. Use common sense. Do not operate appliance when you are tired or under the influence of drugs, alcohol or medication.
- When not in use, appliances should be stored indoors in dry places out of reach of children.
- Maintain appliance with care. Follow instructions for lubricating and changing accessories. Keep handles dry, clean, and free from oil and grease.
- Check damaged parts. Before using the appliance, make sure the safety guards are intact. Never use a tool without its safety guard. Check the alignment of the

moving parts, the binding of the moving parts. Check for broken or defective parts that can affect the safe operation of your tool. A guard or other part that is damaged should be properly repaired or replaced by an authorized service centre unless indicated elsewhere in this manual.

1. FOR ALL BATTERY-OPERATED GARDENING APPLIANCES:

1. Prevent unintentional starting. Ensure the switch is in the off-position before connecting to battery pack, picking up or carrying the appliance. Carrying the appliance with your finger on the switch or energizing appliance that has the switch on invites accidents.
2. Disconnect the battery pack from the appliance before making any adjustments, changing accessories, or storing appliance. Such preventive safety measures reduce the risk of starting the appliance accidentally.
3. Recharge only with the charger specified by the manufacturer. A charger that is suitable for one type of battery pack may create a risk of fire when used with another battery pack.
4. Use appliances only with specifically designated battery packs. Use of any other battery packs may create a risk of injury and fire.
5. When battery pack is not in use, keep it away from other metal objects, like paper clips, coins, keys, nails, screws or other small metal objects, that can make a connection from one terminal to another. Shorting the battery terminals together may cause burns or a fire.
6. Under abusive conditions, liquid may be ejected from the battery; avoid contact. If contact accidentally occurs, flush with water. If liquid contacts eyes, seek



Important Safety Instructions

WARNING: Read all safety warnings and instructions. Failure to follow the warnings and instructions may result in electric shock, fire and/or serious injury.

additional medical help. Liquid ejected from the battery may cause irritation or burns.

7. Do not use a battery pack or appliance that is damaged or modified. Damaged or modified batteries may exhibit unpredictable Canadian spelling resulting in fire, explosion or risk of injury.
8. Do not expose a battery pack or appliance to fire or excessive temperature. Exposure to fire or temperature above 130°C (266°F) may cause an explosion.
9. Follow all charging instructions and do not charge the battery pack or appliance outside of the temperature range specified in the instructions. Charging improperly or at temperatures outside of the specified range may damage the battery and increase the risk of fire.
10. Have servicing performed by a qualified repair person using only identical replacement parts. This will ensure that the safety of the product is maintained.
11. Do not modify or attempt to repair the appliance or the battery pack (as applicable) except as indicated in the instructions for use and care.

ADDITIONAL SAFETY RULES FOR GRASS TRIMMER

1. Keep guards in place and in good working order.
2. Keep hands and feet away from cutting area.
3. Do not use heavier trimmer lines than recommended in this manual.
4. Do not use line materials of other types – for example, metal wire, rope, and the like.

SAFETY WARNINGS FOR BATTERY PACK

- a) **Do not dismantle, open or shred battery pack.**
- b) **Do not expose battery pack to heat or fire. Avoid storage in direct sunlight.**
- c) **Do not short-circuit a battery pack. Do**

not store battery packs haphazardly in a box or drawer where they may short-circuit each other or be short-circuited by other metal objects. When battery pack is not in use, keep it away from other metal objects, like paper clips, coins, keys, nails, screws or other small metal objects, that can make a connection from one terminal to another. Shorting the battery terminals together may cause burns or fire.

- d) **Do not remove battery pack from its original packaging until required for use.**
- e) **Do not subject battery pack to mechanical shock.**
- f) **In the event of battery leaking, do not allow the liquid to come in contact with the skin or eyes. If contact has been made, wash the affected area with copious amounts of water and seek medical advice.**
- g) **Observe the plus (+) and minus (–) marks on the battery back and equipment and ensure correct use.**
- h) **Do not use any battery pack which is not designed for use with the equipment.**
- i) **Keep battery pack out of the reach of children.**
- j) **Seek medical advice immediately if a cell or battery has been swallowed.**
- k) **Always purchase the battery pack recommended by the device manufacturer for the equipment.**
- l) **Keep battery pack clean and dry.**
- m) **Wipe the battery pack terminals with a clean, dry cloth if they become dirty.**
- n) **Battery pack needs to be charged before use. Always use the correct charger and refer to the manufacturer's instructions or equipment manual for proper charging instructions.**
- o) **Do not leave battery pack on prolonged charge when not in use.**
- p) **After extended periods of storage, it may be necessary to charge and discharge the battery pack several times to obtain maximum performance.**

- q) **The battery pack gives its best performance when it is operated at normal room temperature (20°C ± 5°C/68°F ± 9°F).**
- r) **When disposing of battery packs, keep battery packs of different electrochemical systems separate from each other.**
- s) **Recharge only with the charger specified by Yardworks®. Do not use any charger other than that specifically provided for use with the equipment.** A charger that is suitable for one type of battery pack may create a risk of fire when used with another battery pack.
- t) **Retain the original product literature for future reference.**
- u) **Use only the battery pack in the application for which it was intended.**
- v) **Remove the battery pack from the equipment when not in use.**
- w) **Dispose of properly.**

radio frequency energy and, if not installed and used in accordance with the instructions, may cause harmful interference to radio communications.

However, there is no guarantee that interference will not occur in a particular installation. If this equipment does cause harmful interference to radio or television reception, which can be determined by turning the equipment off and on, the user is encouraged to try to correct the interference by one or more of the following measures:

- Reorient or relocate the receiving antenna.
- Increase the separation between the equipment and receiver.
- Connect the equipment into an outlet on a circuit different from that to which the receiver is connected.
- Consult the dealer or an experienced radio/TV technician for help.

Information for radiated emission

This device complies with Canadian ICES-001.

This device complies with Part 15 of the FCC Rules.

Operation is subject to the following two conditions:

- (1) This device may not cause harmful interference, and
- (2) This device must accept any interference received, including interference that may cause undesired operation.

NOTE: This equipment has been tested and found to comply with the limits for a Class B digital device, pursuant to Part 15 of the FCC Rules.













These limits are designed to provide reasonable protection against harmful interference in a residential installation. This equipment generates, uses and can radiate



Warning: Changes or modifications to this unit not expressly approved by the party responsible for compliance could void the user's authority to operate the equipment.

model no. 060-1983-0 | contact us: 1.866.523.5218



Some of the following symbols may be used on this product. Please study them and learn their meaning. Proper interpretation of these symbols will allow you to operate the product effectively and safely.

Symbol	Designation/Explanation
	To reduce the risk of injury, user must read instruction manual
	Wear ear protection
	This part directs thrown objects away from the operator
 Li-ion	Li-ion battery; battery must be recycled
	Do not burn
	Batteries may enter water cycle if disposed improperly, which can be hazardous for ecosystem. Do not dispose of waste batteries as unsorted municipal waste.
 <small>call 2recycle</small>	Yardworks® Canada has established a partnership with the RBRC Corporation to recycle any Yardworks® batteries with the RBRC-call2recycle seal. For environmental protection, please do not discard batteries in the trash. After the battery's life cycle is ended, please call 1-800-822-8837 for a free service that will properly dispose of the battery.
	Warning
	Make sure the battery is removed prior to changing accessories
	Trimming
	Edging
	Lock
	Unlock

SAVE THESE INSTRUCTIONS!

model no. 060-1983-0 | contact us: 1.866.523.5218





PRODUCT SPECIFICATIONS

Voltage	48 V 
No Load Speed	7000/min
Cutting Diameter	13" (33 cm)
Line Diameter	0.080" (2.0 mm)
Line Length	2x8ft (4.9 m)
Battery Capacity (060-1987-2)	2.0 Ah
Charger Input (060-1990-2)	120 V~, 60 Hz, 110 W
Charger Output (060-1990-2)	48 V  , 2 A
Charging Time	1 hr
Machine Weight	11 lb (5 kg)

SUITABLE BATTERY PACKS

Item Number	060-1987-2	ABP4830SH	060-1988-0	ABP4850SH	060-1989-8
Battery Capacity	2.0 Ah	3.0 Ah	4.0 Ah	5.0 Ah	6.0 Ah
	Included	Not included	Not included	Not included	Not included

SUITABLE CHARGERS

Item Number	060-1990-2	060-1992-8
Charger Input	120 V~, 60 Hz, 110 W	120 V~, 60 Hz, 320 W
Charger Output	48 V  , 2 A	48 V  , 6 A
Charger Protection Class	 /II	 /II
	Included	Not included

model no. 060-1983-0 | contact us: 1.866.523.5218

1. Battery pack (060-1987-2)
2. Battery pack release button
3. On/Off switch
4. Lock-off button
5. Auxiliary handle
6. Connector
7. Safety guard
8. Line cutter
9. Trimmer head
10. Spool
11. Bump knob
12. Charger (060-1990-2)
13. Wrench (Fig. A1)
14. Screws (Fig. B)

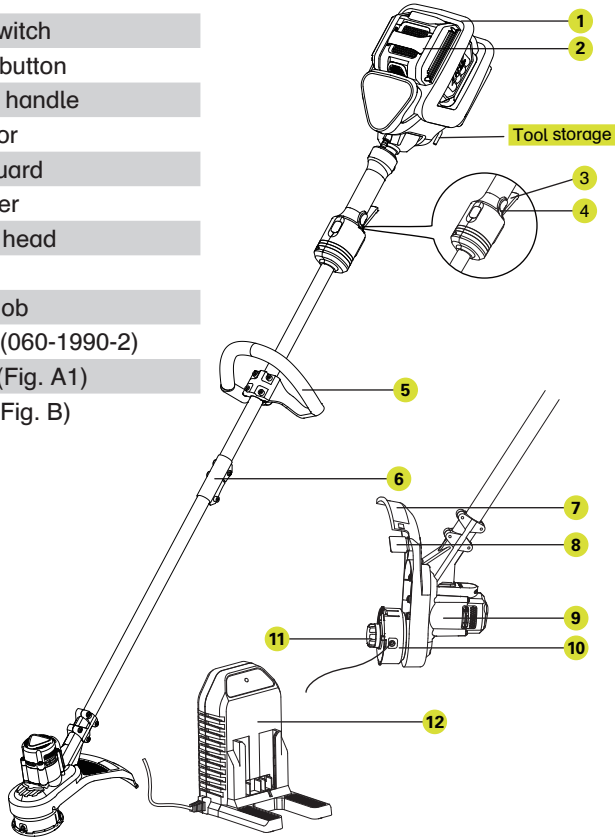

We recommend that you purchase your accessories listed in the above list from the same store that sold you the tool. Refer to the accessory packaging for further details. Store personnel can assist you and offer advice.



WARNING: any other accessory or attachment may increase the risk of injury.



To reduce the risk of injury, user must read instruction manual

Intended Use

The machine is intended for the cutting of grass and weeds under bushes, as well as on slopes and edges that cannot be reached with the lawn mower.

1. ASSEMBLING THE UPPER SHAFT AND LOWER SHAFT

- 1) Loosen the bolt on the connector. (see Fig. A1.)
- 2) Align and insert the lower shaft directly into the upper shaft. (see Fig. A2.)
- 3) Position the locking/release button into the guide recess. (see Fig. A2.)

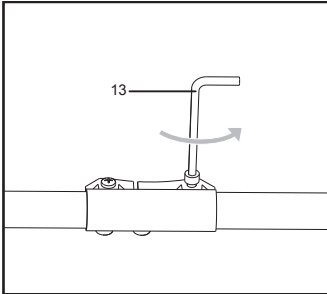

A1

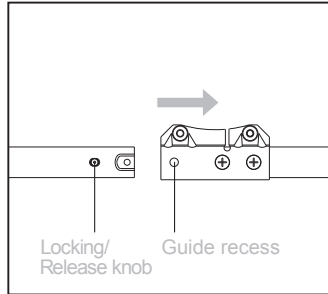

A2

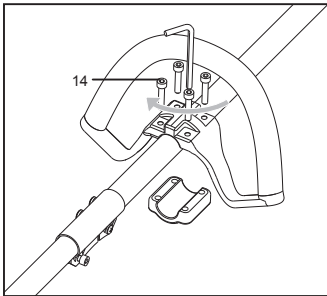

B

2. ASSEMBLING THE AUXILIARY HANDLE

Place the auxiliary handle onto the shaft from the top, align with the anti-vibration circle on the shaft, insert the screws into the four holes, and tighten them with the wrench. (see Fig. B.)



CAUTION! The machine must not be operated before it has been assembled completely.



CAUTION! Do not insert the battery until the appliance has been completely assembled.

3. Assembling the safety guard

Attach the safety guard to the trimmer head. Align the guard so it slides into the slots located on the trimmer head. (see Fig. C1.) Secure the safety guard onto the trimmer head with the screw provided. (see Fig. C2.)

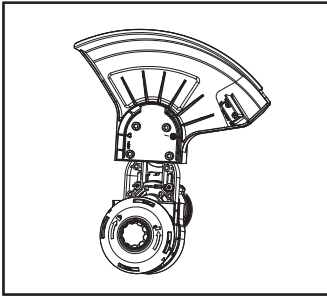

C1

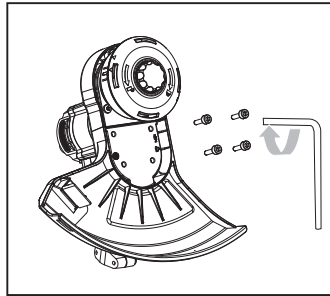

C2

BEFORE OPERATION

1. CHARGING THE BATTERY PACK

IMPORTANT NOTES FOR CHARGING BATTERY

The battery in your new tool is not charged when it leaves the plant; therefore, it must be fully charged before using the first time.

NOTE: If the battery pack is very hot, remove the battery from the charger and allow it to cool to ambient temperature before attempting to recharge.

To prevent damage to the battery pack, please charge the battery to full or no less than half charge before storage.

If the tool will not be used for long periods of time, charge the battery every 3-6 months.

CHARGING PROCEDURE (SEE FIG. D)

- 1) Plug the charger into an appropriate outlet.
- 2) Slide the battery pack into the charger; the light will begin flashing green to indicate the charging process has started.
- 3) When charging is completed, the light will turn solid green. The pack is now fully charged; unplug the charger and remove the battery pack.



WARNING: When battery charge runs out after continuous use or exposure to direct sunlight or heat, allow time for the battery to cool down before re-charging to achieve the full charge.



WARNING! Use caution when assembling the safety guard as the guard has a very sharp line cutter.





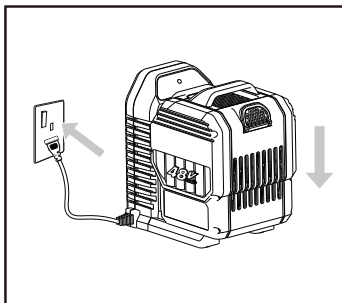



WARNING! Never operate the tool without the guard properly in place. Use of the unit without having installed the guard may result in injury.



D

CHARGING INDICATOR

This charger is designed to detect some problems that can arise with battery packs. Indicator lights indicate problems (see table below).

Light	ON/ Flash	Status
Red on ● 	————	Defective battery.
Red flash  	Battery Temperature Protection. The temperature of battery pack is less than 0°C (32°F) or more than 40°C (104°F).
Green on ● 	————	Fully charged.
Green flash  	Charging.

2. INSTALLING AND REMOVING THE BATTERY PACK

Slide the battery pack into tool's battery port. A simple push and slight pressure will be sufficient. (See Fig. E1.)

Press the battery pack latch and remove the battery pack from the tool. (See Fig. E2.)

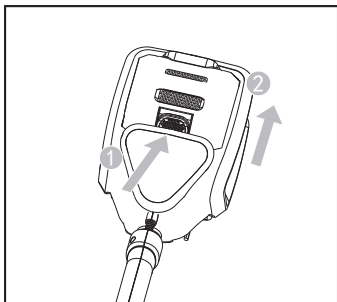

E1

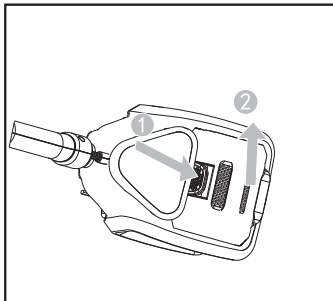

E2

1. SWITCH ON/OFF

To switch on, press the lock-off button first, then the On/Off Switch. (See Fig. F.)
To switch off, release the On/Off Switch.

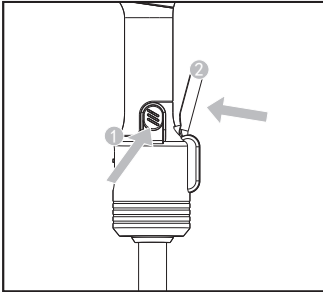

F

2. TRIMMING

- 1) Keep the trimmer head at an angle of about 30° to the ground when trimming. (See Fig. G1.)
- 2) Do not cut wet grass because it tends to stick to the trimmer head and guard, prevents proper discharge of grass clippings, and could cause you to slip and fall.
- 3) Regularly remove clippings and dirt around the trimmer head. Ensure the trimmer is switched off.
- 4) Work rhythmically; stand firmly with your feet apart. Cut from right to left so the trimmings will be thrown away from the work area. (see Fig. G2.)
- 5) When cutting longer/high grass, please make sure that you cut it down in 2 to 3 stages. (see Fig. G3, G4.)
- 6) Do not move the trimmer too fast as this will result in ineffective cutting and possible damage.

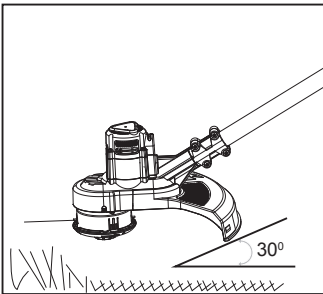

G1

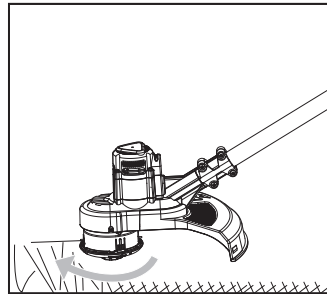

G2



WARNING: Always wear eye protection. Never lean over the trimmer head. Rocks or debris can ricochet or be thrown into eyes and face and cause blindness or other serious injury.



WARNING: Make sure that line is fed out before operation. Make sure motor is up to full speed before trimming.

model no. 060-1983-0 | contact us: 1.866.523.5218

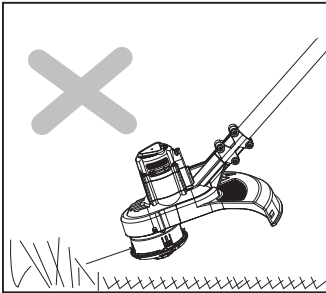

G3

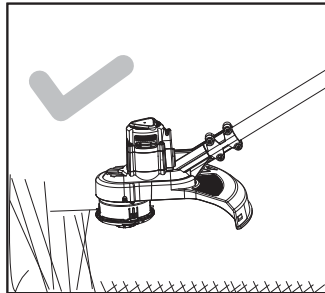

G4

3. ADJUSTING CUTTING LINE LENGTH—AUTOMATIC BUMP LINE FEED

The trimmer head allows the operator to release more cutting line without stopping the motor. As line becomes frayed or worn, additional line can be released by lightly tapping the bump knob on the ground while operating the trimmer. (see Fig. H.)

NOTE: Line release will become more difficult if the cutting line becomes too dull.

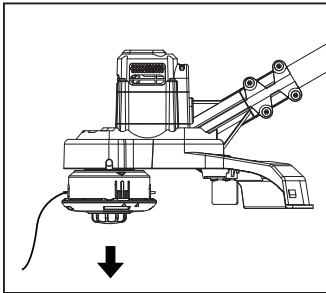

H



WARNING: Do not remove or alter the line-cutting blade assembly. Excessive line length will be cut to suitable length.

4. TO REPLACE THE SPOOL AND LINE

- 1) For your convenience, it is recommended you buy a replacement spool with line.
 - 2) Press and hold in the two cap release latches. Loosen the cap by rotating it counter-clockwise. Pull cap away from the spool holder. (see Fig. I1.)
 - 3) Remove old spool. (see Fig. I2.)
 - 4) Place new spool into cutting head. Release one line from cleat and feed line through eyelet. (see Fig. I3.)
 - 5) Replace the cap on the spool holder and turn the cap clockwise to tighten. (see Fig. I4.)
- NOTE:** If required, line can be fed out manually. Gently pull out the 2 lines out until the lines reach the line cutter. If the line extends past the line cutter, too much line has been fed out. If too much line is fed out, remove the spool cap and click spool counter-clockwise until the line is at the desired length.

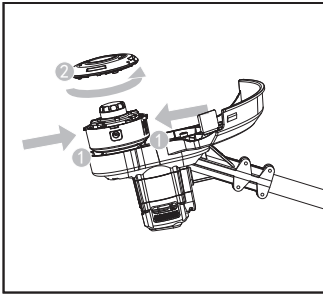

I1

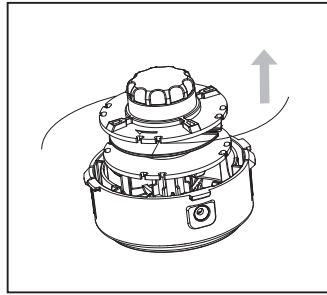

I2

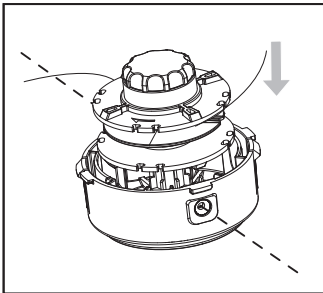

I3

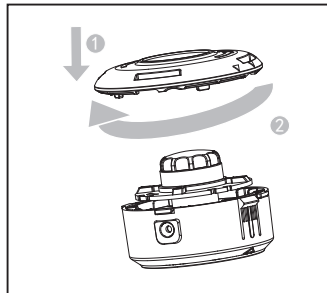

I4



NOTE: Remove battery prior to replacing the spool and line.

5. TO REPLACE THE LINE ON THE SPOOL

- 1) Cut a piece of line approximately 16' (4.9 m) long.
- 2) Insert the centre point of line into the notch in the middle section of the spool and wind the line in a clockwise direction as shown. (see. Fig. J1.)
- 3) Care should be taken to ensure that the line is neatly coiled on the spool. Failure to do so will impair the efficiency of the automatic bump line feed. (see. Fig. J2.)
- 4) Fit the spool as described in "To Replace the Spool and Line".

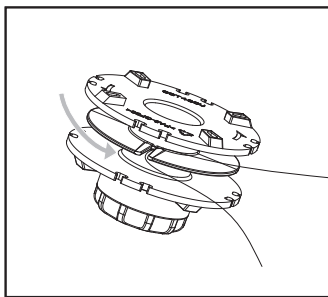

J1

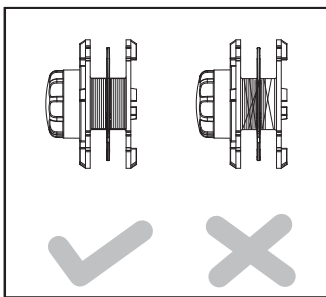

J2



WARNING! Your trimmer is designed to only use line with a maximum diameter of 0.08" (2 mm).



Always remove the battery pack from your trimmer after use.

MAINTENANCE

Always check the product prior to use for any damage.

After use, disconnect the battery from the tool and check for damage.

Your power tool requires no additional lubrication or maintenance. There are no user-serviceable parts in your power tool. Never use water or chemical cleaners to clean your power tool. Wipe clean with a dry cloth. Always store your power tool in a dry, room-temperature location. Keep the motor ventilation slots clean. Keep all working controls free of dust.

For Battery Tools

The ambient temperature range for the use and storage of tool and battery is 0 to 45°C (32 to 113°F).

The recommended ambient temperature range for the charging system during charging is 0 to 40°C (32 to 104°F).

It is recommended that the battery be stored indoors for the winter months.

STORING YOUR GRASS TRIMMER**TO STORE YOUR GRASS TRIMMER**

Store in a dry place where the trimmer and battery can be protected from damage.

The following table gives problems and actions that you can perform if your machine does not operate correctly. Warning: Switch the machine off and remove the battery prior to any troubleshooting.

Problems	Possible Causes	Corrective Action
Trimmer fails to operate.	Battery discharged. Battery too hot/cold. Motor is broken. Internal wiring of machine damaged.	Recharge battery; also see the content in charger manual. Allow to cool/warm. Contact Yardworks [®] at 1.866.523.5218. Contact Yardworks [®] at 1.866.523.5218.
Trimmer runs intermittently.	Motor is broken. Battery not fully charged. On/Off switch defective.	Contact Service Agent. Recharge battery. Contact Yardworks [®] at 1.866.523.5218.
Excessive vibrations /noise.	Machine defective. Line spool is not wound well.	Contact Yardworks [®] at 1.866.523.5218. Rewind the line. See "To Replace the Line on the Spool".
Cutting time per battery charge too short.	Battery has not been used for long period or only charged for short term. Grass too high. Battery defective.	Fully charge battery; also see the content in charger manual. Cut in stages. Replace the battery.
Machine does not cut.	Line broken. Battery not fully charged. Motor is broken (speed is too low). Grass entangled around cutting head.	Replace the line. Recharge battery; also see the content in charger manual. Contact Yardworks [®] at 1.866.523.5218. Remove grass.
Continuous lighting of the battery charge indicator/ battery not charging.	Battery not (properly) inserted. Battery contacts contaminated.	Properly insert battery into battery charger. Clean the battery contacts or replace the battery.
Battery charge indicator does not light up.	Battery defective. Plug of battery charger not plugged in (properly). Outlet or mains cable defective. Battery charger defective.	Replace the battery. Insert mains plug (fully) into the socket outlet. Check the mains voltage. Replace the battery charger.

Exploded View

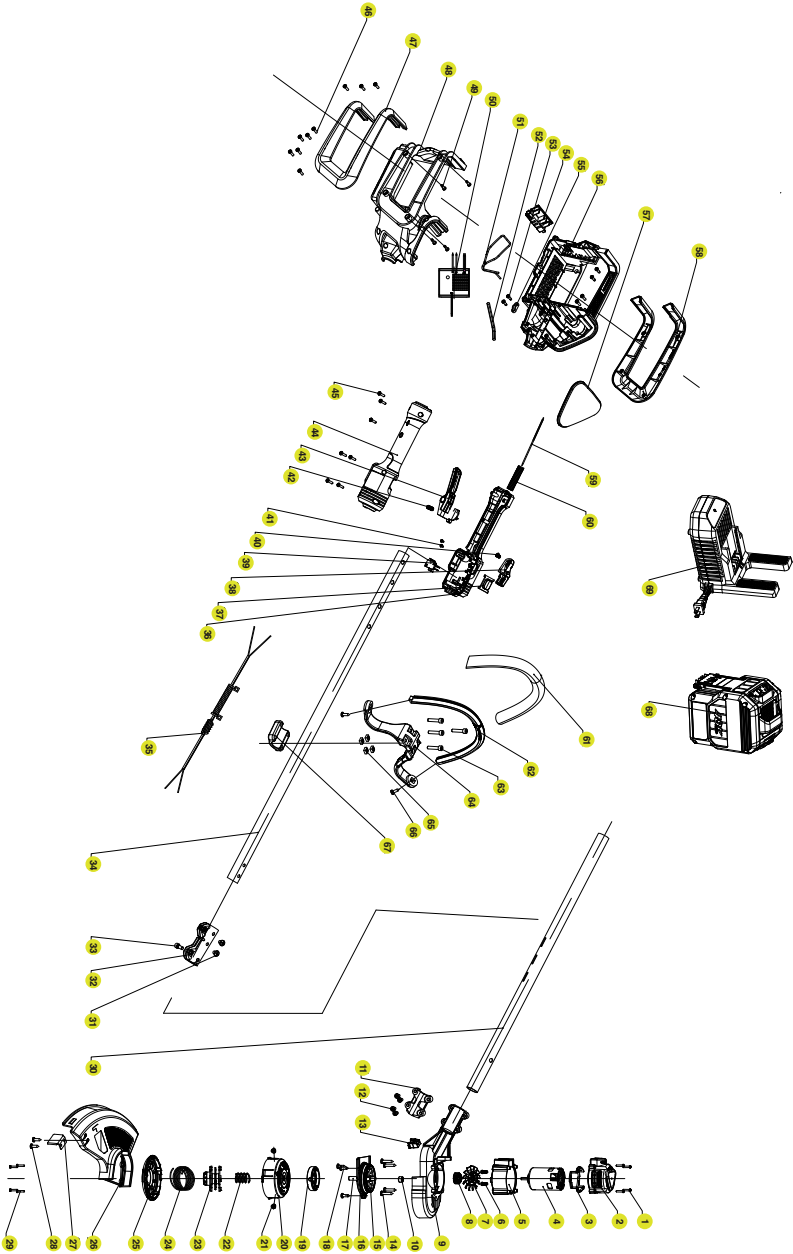

model no. 060-1983-0 | contact us: 1.866.523.5218

NO.	Part Description	Quantity			Quantity
1	Self-Tapping Screw	4	40	Compression Spring	1
2	Rear Cover	1	41	Self Tapping Screw	2
3	Baffle	1	42	Compression Spring	1
4	Motor	1	43	Trigger	1
5	Housing	1	44	Right_handle	1
6	Screw	2	45	Self Tapping Screw	7
7	Fan	1	46	Self Tapping Screw	9
8	Gear	1	47	Right Side Cover	1
9	Flange	1	48	Right_battery_support	1
10	Gear Box Body	1	49	Self Tapping Screw	8
11	Flange	1	50	Protect Control Board	1
12	Self Tapping Screw	4	51	Torsional Spring	1
13	Cover	1	52	Spanner	1
14	Self Tapping Screw	4	53	Self Tapping Screw	2
15	Gear	1	54	Terminal	1
16	Gear Cover	1	55	Cord Clamp	1
17	Output Shaft	1	56	Left_battery_support	1
18	Self Tapping Screw	3	57	Cover	1
19	Inner Flange	1	58	Left Side Cover	1
20	Cutting Head	1	59	Internal Wire	1
21	Rivet	2	60	Corrugated Pipe	1
22	Compression Spring	1	61	TUBE	1
23	Spool	1	62	Auxiliary Handle	1
24	Cutting Line	1	63	Screw	4
25	Cutting Head Cover	1	64	Steady Handle Supper	1
26	Guard	1	65	Nut	4
27	Cutting Blade	1	66	Self Tapping Screw	2
28	Self Tapping Screw	2	67	Steady Handle Cover	1
29	Self Tapping Screw	4	68	Battery Pack	1
30	Aluminium_tube	1	69	Charger	1
31	Self Tapping Screw	2			
32	Connect Sheath	1			
33	Screw	1			
34	Aluminium_tube	1			
35	Coiled Cable	1			
36	Left_handle	1			
37	Cover	1			
38	Lock Knob	1			
39	Switch	1			

FIVE-YEAR LIMITED WARRANTY

For five (5) years from the date of purchase within Canada, YARDWORKS CANADA will, at its option, repair or replace for the original purchaser, free of charge, any part or parts found to be defective in material or workmanship (excludes battery).

For THREE (3) years from the date of purchase within Canada, YARDWORKS CANADA will, at its option, repair or replace for the original purchaser, free of charge, any battery found to be defective in material or workmanship.

THIS WARRANTY DOES NOT COVER

1. Any part that has become inoperative due to misuse, commercial use, abuse, neglect, accident, improper maintenance, or alteration;
2. The unit, if it has not been operated and/or maintained in accordance with the owner's manual;
3. Normal wear, except as noted below;
4. Routine maintenance items such as lubricants, blade sharpening; or
5. Normal deterioration of the exterior finish due to use or exposure.

FULL ONE YEAR (365) DAYS WARRANTY ON NORMAL WEAR PARTS

Normal wear parts are defined as blade adaptors, blades, grass bags and tires. These parts are warranted to the original purchaser to be free from defects in material and workmanship for a period of three hundred and sixty-five (365) days from the date of retail purchase.

Made in China. Imported by Yardworks Canada
Toronto, Canada M4S 2B8

HOW TO OBTAIN SERVICE

Warranty service is available by calling the toll-free helpline at 1.866.523.5218. The factory will not accept the return of a complete unit unless prior written permission has been extended by YARDWORKS CANADA.

TRANSPORTATION CHARGES

Transportation charges for the movement of any power equipment unit or attachment are the responsibility of the purchaser. The purchaser must pay transportation charges for any part submitted for replacement under this warranty unless such return is requested in writing by YARDWORKS CANADA.

OTHER WARRANTIES

All other warranties, express or implied, including any implied warranty of merchantability is limited in its duration to that set forth in this express limited warranty. The provisions as set forth in this warranty provide the sole and exclusive remedy of YARDWORKS CANADA obligations arising from the sale of its products.



Always remove or disconnect the battery pack before adjusting, cleaning, servicing or transporting your appliance.



model no. 060-1983-0 | contact us: 1.866.523.5218

FCC Part 15

Supplier's Declaration of Conformity
Product Description: 48V 2.0A Charger
Model Number: 060-1990-2
Trade Name: YARDWORKS®

This device complies with part 15 of the FCC Rules.

Operation is subject to the following two conditions:

- (1) This device may not cause harmful interference, and
- (2) This device must accept any interference received, including interference that may cause undesired operation.

Responsible Party:

Positec USA, Inc.

PO Box 681298, Charlotte, NC 28216

Tel: 1 - (866) - 523 - 5218

Fax: (704) 599-6390

13" (33 CM) CORDLESS GRASS TRIMMER

Item # 060-1983-0 | contact us: 1.866.523.5218

1. ASSEMBLING THE UPPER SHAFT AND LOWER SHAFT

- Loosen the bolt on the connector. (See Fig. A1.)
- Align and insert the lower shaft directly into the upper shaft. (See Fig. A2.)
- Position the locking/release button into the guide recess. (See Fig. A2.)

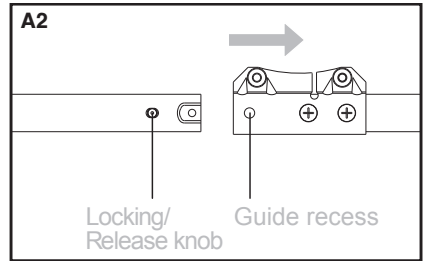
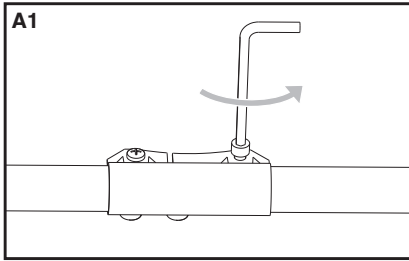
2. ASSEMBLING THE AUXILIARY HANDLE

Place the auxiliary handle onto the shaft from the top, align with the anti-vibration circle on the shaft, screw into four holes, and tighten it with the wrench. (See Fig. B.)

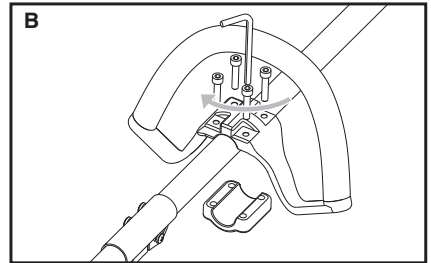
3. ASSEMBLING THE SAFETY GUARD

- Attach the safety guard to the trimmer head. Align the guard so it slides into the slots located on the trimmer head. (See Fig. C1.)
- Secure the safety guard onto the trimmer head with the bolts provided by using the wrench. (See Fig. C2.)
- Please put the wrench back to the top notch of grass trimmer after use, so it will not get lost. (See Fig. C3.)

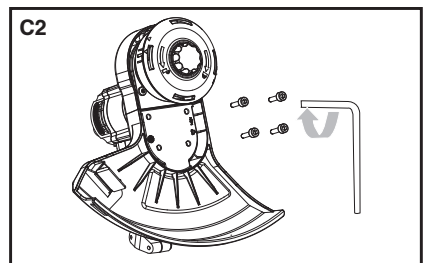
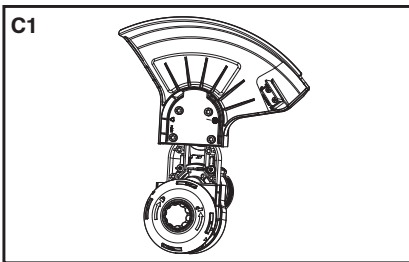

* This information is provided for your convenience. It does not replace the instruction manual and safety instructions. The manual and safety instructions need to be read and understood in their entirety.

13" (33 CM) CORDLESS GRASS TRIMMER

Item # 060-1983-0 | contact us: 1.866.523.5218

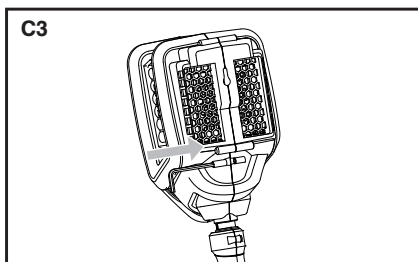
**BEFORE OPERATION****1. CHARGING PROCEDURE (SEE FIG. D.)**

- Plug the charger into an appropriate outlet.
- Slide the battery pack into the charger; the light will begin flashing green to indicate the charging process has started.
- When charging is completed, the light will turn solid green. The pack is now fully charged; unplug the charger and remove the battery pack.

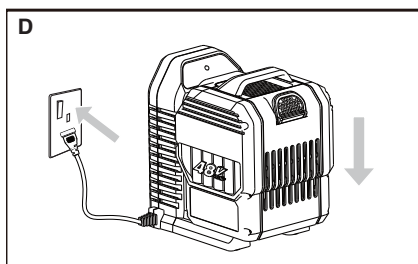
**2. INSTALLING AND REMOVING THE BATTERY PACK**

Slide the battery pack into tool's battery port. A simple push and slight pressure will be sufficient. Press the battery pack latch and remove the battery pack from the tool. (See Fig. E.)

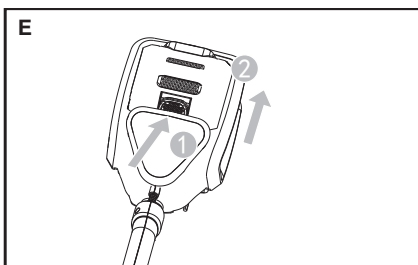

* This information is provided for your convenience. It does not replace the instruction manual and safety instructions. The manual and safety instructions need to be read and understood in their entirety.