

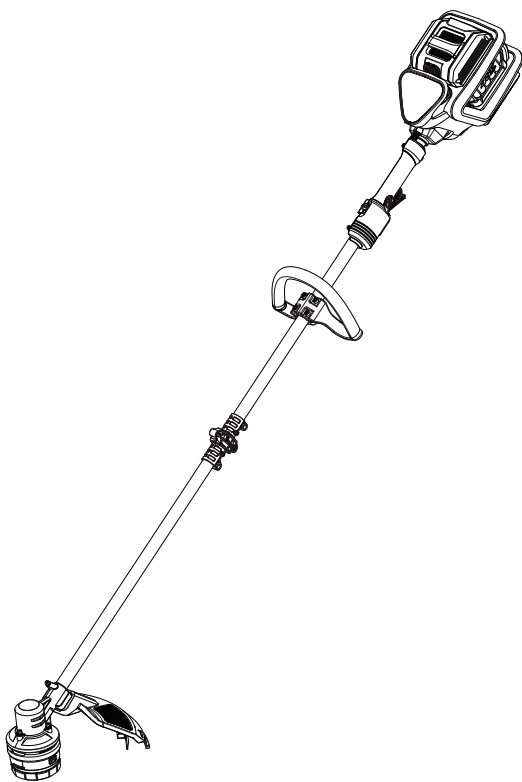

YARDWORKS^{®/MD}

15" (38.1 CM) BRUSHLESS GRASS TRIMMER

model number 060-1913-8 | contact us: 1.866.523.5218



IMPORTANT:

Read and follow all safety rules and operating instructions before using this product.

**Instruction
Manual**



For problems or questions, **DO NOT RETURN TO STORE**. Please contact one of our Customer Service Agents who would be happy to assist you.

For Customer Assistance Please Call:



CANADA: 1.866.523.5218

Introduction	4
Safety Instructions & Symbols	5
Product Specifications	9
Product Diagram	10
Assembly	11
Operation	14
Maintenance	17
Storage	18
Troubleshooting	19
Exploded View	20
Parts List	21
Warranty	22

model no. 060-1913-8 | contact us: 1.866.523.5218



Please do not operate garden equipment near children. This could lead to severe injury or death.

INTRODUCTION

Congratulations on your purchase of your new Yardworks® tool. It has been designed, engineered and manufactured to give you the best possible dependability and performance.

Should you experience any problem you cannot easily remedy, please contact our Yardworks® customer service line at 1.866.523.5218.

PLEASE READ AND RETAIN THIS INSTRUCTION MANUAL. These instructions will enable you to assemble and maintain your appliance properly. **ALWAYS** observe the "SAFETY RULES".

The instruction manual was designed to conveniently help you get your purchase ready to use so there's less risk of damaging it and so you may features so you may operate provide you with enough information to get familiar with your product's controls and features and to operate it safely.

SAFETY FIRST



CAUTION: The operation of lawn equipment can result in foreign objects thrown into the eyes, which can result in SEVERE EYE INJURY. ALWAYS wear safety glasses or eye shields while operating your lawn equipment or performing any adjustments or repairs. We recommend standard safety glasses or a wide vision safety mask worn over spectacles.



Please read this manual carefully and make sure you understand the instructions before using the machine.

Model number: _____

Serial number: _____

Date of purchase (MM/DD/YYYY): _____

Notes: _____

FOR ALL APPLIANCES

- Avoid dangerous environments — do not use appliances in damp or wet locations.
- Don't use in rain.
- Keep children away — all people and pets should be kept at a distance from the work area.
- Dress properly — do not wear loose clothing or jewellery. They can be caught in moving parts. Wear protective clothing; use of work gloves, long pants, a long-sleeved shirt and safety footwear is recommended when working outdoors. Wear protective hair covering to contain long hair.
- Use safety glasses — always use face or dust mask if the area in which you are working is dusty.
- Use the right appliance — do not use appliance for any job except that for which it is intended.
- Do not force appliance — it will do the job better and with less likelihood of a risk of injury at the rate for which it was designed.
- Do not overreach — keep proper footing and balance at all times.
- Stay alert. Use common sense. Do not operate appliance when you are tired or under the influence of drugs, alcohol or medication.
- When not in use, appliances should be stored indoors in dry places out of reach of children.
- Maintain appliance with care. Follow instructions for lubricating and changing accessories. Keep handles dry, clean, and free from oil and grease.
- Check damaged parts. Before using the appliance, make sure the safety guards are intact. Never use a tool without its

safety guard. Check the alignment of the moving parts, the binding of the moving parts. Check for broken or defective parts that can affect the safe operation of your tool. A guard or other part that is damaged should be properly repaired or replaced by an authorized service centre unless indicated elsewhere in this manual.

1. FOR ALL BATTERY-OPERATED GARDENING APPLIANCES:

1. Prevent unintentional starting. Ensure the switch is in the off-position before connecting to battery pack, picking up or carrying the appliance. Carrying the appliance with your finger on the switch or energizing an appliance that has the switch on invites accidents.
2. Disconnect the battery pack from the appliance before making any adjustments, changing accessories, or storing appliance. Such preventive safety measures reduce the risk of starting the appliance accidentally.
3. Recharge only with the charger specified by the manufacturer. A charger that is suitable for one type of battery pack may create a risk of fire when used with another battery pack.
4. Use appliances only with specifically designated battery packs. Use of any other battery packs may create a risk of injury and fire.
5. When battery pack is not in use, keep it away from other metal objects, like paper clips, coins, keys, nails, screws or other small metal objects, that can make a connection from one terminal to another. Shorting the battery terminals together may cause burns or a fire.
6. Under abusive conditions, liquid may be ejected from the battery; avoid contact.

**Important Safety Instructions**

WARNING: Read all safety warnings and instructions. Failure to follow the warnings and instructions may result in electric shock, fire and/or serious injury.

If contact accidentally occurs, flush with water. If liquid contacts eyes, additionally seek medical help. Liquid ejected from the battery may cause irritation or burns.

7. Do not use a battery pack or appliance that is damaged or modified. Damaged or modified batteries may exhibit unpredictable behaviour resulting in fire, explosion or risk of injury.
8. Do not expose a battery pack or appliance to fire or excessive temperature. Exposure to fire or temperature above 265°F(130°C) may cause an explosion.
9. Follow all charging instructions and do not charge the battery pack or appliance outside of the temperature range specified in the instructions. Charging improperly or at temperatures outside of the specified range may damage the battery and increase the risk of fire.
10. Have servicing performed by a qualified repair person using only identical replacement parts. This will ensure that the safety of the product is maintained.
11. Do not modify or attempt to repair the appliance or the battery pack (as applicable) except as indicated in the instructions for use and care.

ADDITIONAL SAFETY RULES FOR LAWN TRIMMER AND EDGE TRIMMER

1. Keep guards in place and in good working order.
2. Keep hands and feet away from cutting area.
3. Do not use heavier lines than recommended in this manual.
4. Do not use line materials of other types – for example, metal wire, rope, and the like.

SAFETY WARNINGS FOR BATTERY PACK

- a) **Do not dismantle, open or shred battery pack.**
- b) **Do not expose battery pack to heat or fire. Avoid storage in direct sunlight.**

- c) **Do not short-circuit a battery pack. Do not store battery packs haphazardly in a box or drawer where they may short-circuit each other or be short-circuited by other metal objects.** When battery pack is not in use, keep it away from other metal objects, like paper clips, coins, keys, nails, screws or other small metal objects, that can make a connection from one terminal to another. Shorting the battery terminals together may cause burns or fire.
- d) **Do not remove battery pack from its original packaging until required for use.**
- e) **Do not subject battery pack to mechanical shock.**
- f) **In the event of battery leaking, do not allow the liquid to come in contact with the skin or eyes. If contact has been made, wash the affected area with copious amounts of water and seek medical advice.**
- g) **Observe the plus (+) and minus (–) marks on the battery back and equipment and ensure correct use.**
- h) **Do not use any battery pack which is not designed for use with the equipment.**
- i) **Keep battery pack out of the reach of children.**
- j) **Seek medical advice immediately if a cell or battery has been swallowed.**
- k) **Always purchase the battery pack recommended by the device manufacturer for the equipment.**
- l) **Keep battery pack clean and dry.**
- m) **Wipe the battery pack terminals with a clean, dry cloth if they become dirty.**
- n) **Battery pack needs to be charged before use. Always use the correct charger and refer to the manufacturer's instructions or equipment manual for proper charging instructions.**
- o) **Do not leave battery pack on prolonged charge when not in use.**
- p) **After extended periods of storage, it may be necessary to charge and discharge the battery pack**

- several times to obtain maximum performance.
- q) **The battery pack gives its best performance when it is operated at normal room temperature (68°F ± 9°F/20°C ± 5°C).**
 - r) **When disposing of battery packs, keep battery packs of different electrochemical systems separate from each other.**
 - s) **Recharge only with the charger specified by Yardworks®. Do not use any charger other than that specifically provided for use with the equipment.** A charger that is suitable for one type of battery pack may create a risk of fire when used with another battery pack.
 - t) **Retain the original product literature for future reference.**
 - u) **Use only the battery pack in the application for which it was intended.**
 - v) **Remove the battery pack from the equipment when not in use.**
 - w) **Dispose of properly.**

Information for radiated emission

This device complies with Canadian ICES-001.

This device complies with Part 15 of the FCC Rules.

Operation is subject to the following two conditions:

- (1) This device may not cause harmful interference, and
- (2) This device must accept any interference received, including interference that may cause undesired operation.

NOTE: This equipment has been tested and found to comply with the limits for a Class B digital device, pursuant to Part 15 of the FCC Rules.

These limits are designed to provide reasonable protection against harmful interference in a residential installation. This

equipment generates, uses and can radiate radio frequency energy and, if not installed and used in accordance with the instructions, may cause harmful interference to radio communications.













However, there is no guarantee that interference will not occur in a particular installation. If this equipment does cause harmful interference to radio or television reception, which can be determined by turning the equipment off and on, the user is encouraged to try to correct the interference by one or more of the following measures:

- Reorient or relocate the receiving antenna.
- Increase the separation between the equipment and receiver.
- Connect the equipment into an outlet on a circuit different from that to which the receiver is connected.
- Consult the dealer or an experienced radio/TV technician for help.



WARNING: Changes or modifications to this unit not expressly approved by the party responsible for compliance could void the user's authority to operate the equipment.



Some of the following symbols may be used on this product. Please study them and learn their meaning. Proper interpretation of these symbols will allow you to operate the product effectively and safely.

Symbol	Designation/Explanation
	To reduce the risk of injury, user must read instruction manual
	Wear ear protection
	This part directs thrown objects away from the operator
 Li-ion	Li-ion battery; battery must be recycled
	Do not burn
	Batteries may enter water cycle if disposed improperly, which can be hazardous for ecosystem. Do not dispose of waste batteries as unsorted municipal waste.
	Yardworks® Inc. has established a partnership with the RBRC Corporation to recycle any Yardworks® batteries with the RBRC-call2recycle seal. For environmental protection, please do not discard batteries in the trash. After the battery's life cycle is ended, please call 1-800-822-8837 for a free service that will properly dispose of the battery.
	Warning
	Make sure the battery is removed prior to changing accessories
	Trimming
	Edging
	Lock
	Unlock

SAVE THESE INSTRUCTIONS!

model no. 060-1913-8 | contact us: 1.866.523.5218





TECHNICAL DATA

Voltage	48V 
Speed	Power sense mode: 4500/min to 6000/min; MAX mode: 6000/min
Cutting Diameter	15" (38 cm)
Line Diameter	0.094" (2.39 mm)
Line length	16 ft (4.9 m)
Battery capacity (060-1987-2)	2.0 Ah
Charger Input(060-1990-2)	120 V~, 60 Hz, 110 W
Charger Output(060-1990-2)	48 V  , 2 A
Charging time	1 hr
Machine Weight	11 lb 7 oz (5.2 kg)

SUITABLE BATTERY PACKS

Item Number	060-1987-2	ABP4830SH	060-1988-0	ABP4850SH	060-1989-8
Battery Capacity	2.0 Ah	3.0 Ah	4.0 Ah	5.0 Ah	6.0 Ah
	Included	Not included	Not included	Not included	Not included

SUITABLE CHARGERS

Item Number	060-1990-2	060-1992-8
Charger Input	120 V~, 60 Hz, 110 W	120 V~, 60 Hz, 320 W
Charger Output	48 V  , 2 A	48 V  , 6 A
Charger Protection Class	 /II	 /II
	Included	Not included

model no. 060-1913-8 | contact us: 1.866.523.5218

1. Battery pack (060-1987-2)
2. Battery pack release button
3. On/Off switch
4. Lock-off button
5. **Mode selecting control**
6. Auxiliary handle
7. Upper shaft
8. Couplings
9. Lower shaft
10. Safety guard
11. Spool holder
12. Line cutter
13. Bump knob
14. Line fitting knob
15. Line fitting hole
16. Trimmer head
17. Charger (060-1990-2)
18. Hex key x 2 (Fig. A2 & C1)
19. Bolt x 7 (Fig. A2, B & C1)
20. Spool holder release knob x 2 (Fig. K1)

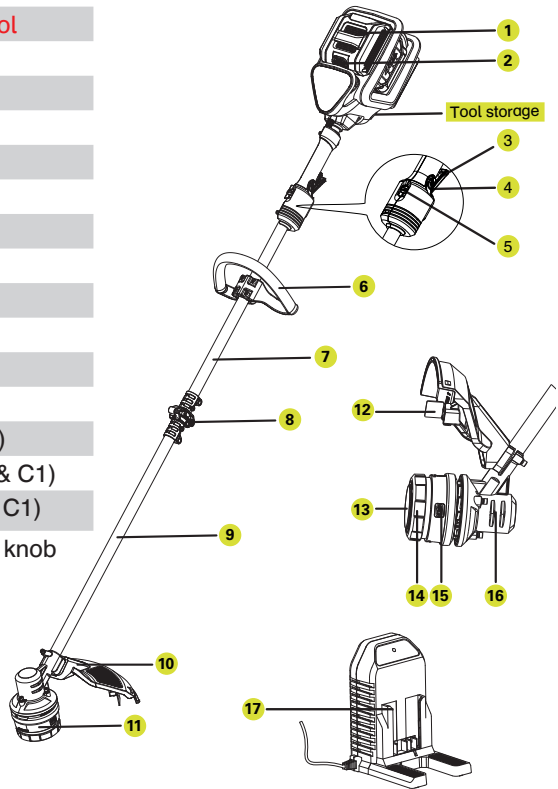

We recommend that you purchase your accessories listed in the above list from the same store that sold you the tool. Refer to the accessory packaging for further details. Store personnel can assist you and offer advice.



WARNING: Any other accessory or attachment may increase the risk of injury.



To reduce the risk of injury, user must read instruction manual.

Intended Use

The machine is intended for the cutting of grass and weeds under bushes, as well as on slopes and edges that cannot be reached with a lawn mower.

1. Assembling the upper shaft and lower shaft

Connect the couplings into each other (see Fig. A1). Align the holes and fasten the couplings by screwing the bigger bolt with the bigger hex key (see Fig. A2).

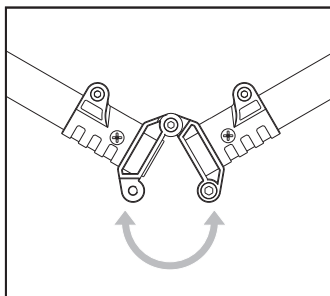

A1

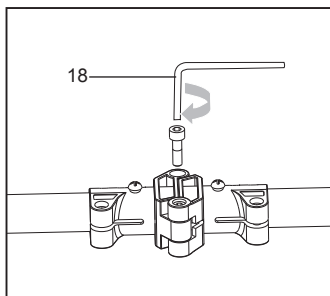

A2

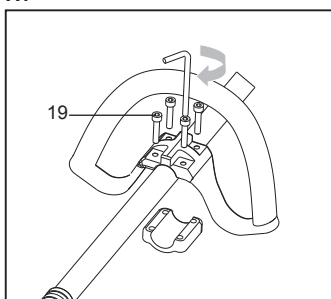

B

2. Assembling the auxiliary handle

Place the auxiliary handle onto the shaft and align with the anti-vibration circle on the shaft. Tighten the auxiliary handle by screwing the four bolts with the hex key (see Fig. B).



CAUTION! The trimmer must not be operated before it has been assembled completely.



CAUTION! Do not insert the battery until the trimmer has been completely assembled.

3. Assembling the safety guard

Attach the safety guard to the lower shaft as shown in Fig. C1. Align the 2 holes on the safety guard with the 2 corresponding holes on the lower shaft.

Hold the safety guard in place and insert the 2 small bolts into the 2 aligned holes.

Secure the safety guard onto the lower shaft with the provided hex key (see Fig. C2).

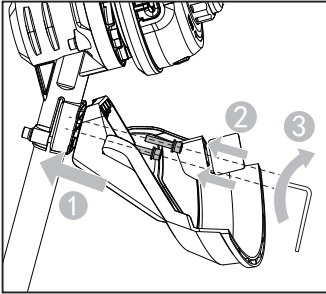

C1

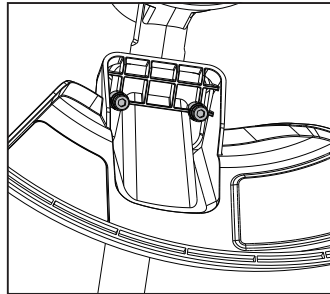

C2

BEFORE OPERATION

1. Charging the battery pack

IMPORTANT NOTES FOR CHARGING BATTERY

The battery in your new tool is not charged when it leaves the plant; therefore, it must be fully charged before using the first time.

NOTE: If the battery pack is very hot, remove the battery from the charger and allow it to cool to ambient temperature before attempting to recharge.

To prevent damage to the battery pack, please charge the battery to full or no less than half charge before storage.

If the tool will not be used for long periods of time, charge the battery every 3 – 6 months.

Charging procedure (SEE FIG. D)

- 1) Plug the charger into an appropriate outlet.
- 2) Slide the battery pack into the charger; the light will begin flashing green to indicate the charging process has started.
- 3) When charging is completed, the light will turn solid green. The pack is now fully charged; unplug the charger and remove the battery pack.



WARNING: When battery charge runs out after continuous use or exposure to direct sunlight or heat, allow time for the tool to cool down before re-charging to achieve the full charge.



WARNING: Never use the tool without the guard properly in place. Using the device without the protector installed may result in injury.



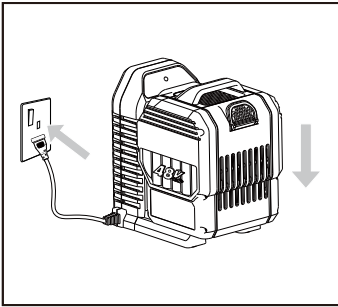





model no. 060-1913-8 | contact us: 1.866.523.5218



D

Charging indicator

This charger is designed to detect some problems that can arise with battery packs. Indicator lights indicate problems (see table below).

Light	ON/ Flash	Status
Red on ●  	————	Defective battery.
Red flash  	Battery Temperature Protection. The temperature of battery pack is less than 32°F (0°C) or more than 104°F (40°C).
Green on ●  	————	Fully charged.
Green flash  	Charging.

2. Installing and removing the battery pack

Slide the battery pack into tool's battery port. A simple push and slight pressure will be sufficient (see Fig. E1).

Press the battery pack latch and remove the battery pack from the tool (see Fig. E2).

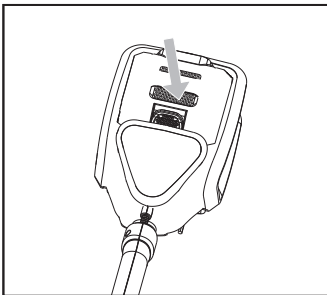

E1

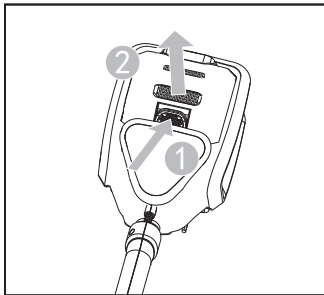

E2

1. Switch On/Off

To switch on, press the lock-off button first, then the On/Off switch (see Fig. F).
To switch off, release the On/Off switch.

2. Mode selecting control

The trimmer has a two mode speed control designed for working at power sense mode (mark is 1) and MAX mode (mark is 2) (see Fig. G). Select different mode according to the required working condition.

NOTE:

Power sense mode: automatically adjusts the cutting speed according to the working conditions to extend the running time, lower speed for light duty work and high speed for heavy duty work;

MAX mode: high speed for more efficiency and heavy duty jobs.

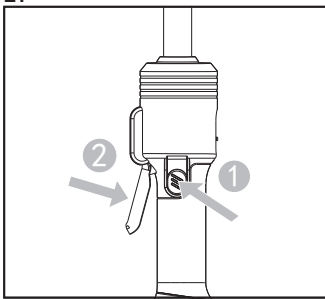

F

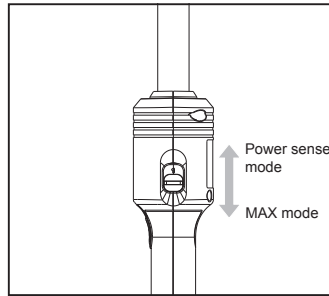

G

3. Trimming

- 1) Keep the trimmer head at an angle of about 30° to the ground when trimming (see Fig. H1).
- 2) Do not cut wet grass because it tends to stick to the trimmer head and guard, prevents proper discharge of grass clippings, and could cause you to slip and fall.
- 3) Regularly remove clippings and dirt around the trimmer head with a switched off trimmer.
- 4) Work rhythmically, stand firmly with your feet apart. Cut from right to left so the trimmings will be thrown away from the work area (see Fig. H2).
- 5) When cutting long or high grass, please make sure that you cut this down in 2 to 3 stages (see Fig. H3, H4).
- 6) Do not move the trimmer too fast as this will result in ineffective cutting and possible damage.



WARNING: Always wear eye protection. Never lean over the trimmer head. Rocks or debris can ricochet or be thrown into eyes and face and cause blindness or other serious injury.



WARNING: Make sure that line is fed out before operation. Make sure motor is up to full speed before trimming.



WARNING: Do not remove or alter the line-cutting blade assembly. Excessive line length will be cut to suitable length.

model no. 060-1913-8 | contact us: 1.866.523.5218

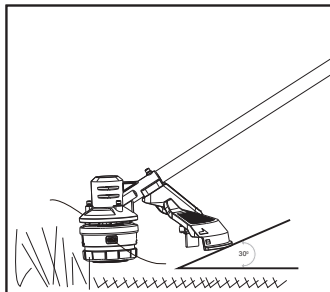

H1

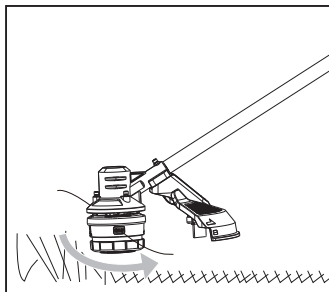

H2

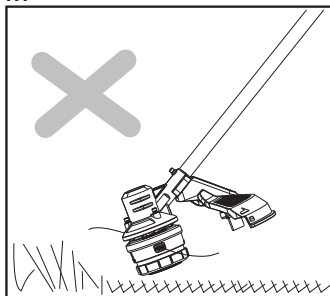

H3

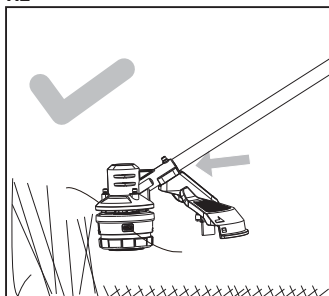

H4

4. Adjusting cutting line length

The trimmer head allows the operator to release more cutting line without stopping the motor. As line becomes frayed or worn, additional line can be released by lightly tapping the bump knob on the ground while operating the trimmer (see Fig. I).

NOTE: Line release will become more difficult if the line cutter becomes dull.

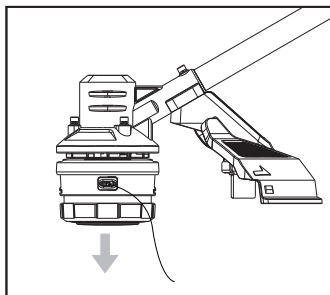

I

5. Replacing the line only

With the automatic line fitting system, you only need to replace the line instead of replacing the whole spool holder, also without winding the line manually.

- 1) Take a line of approximately 16' (4.9 m).
- 2) Turn over the grass trimmer. Rotate the spool holder anti-clockwise, and insert one end of the line continuously into a line fitting hole at the edge side of the spool holder, and the line will go through the inner spool holder itself and stretch out from the other line fitting hole (see Fig. J1).
- 3) Pull out the other end of the line until half of the line is stretched out from the other hole. Note that the length of the two parts line should be the same (see Fig. J2).
- 4) Hold the spool holder by hand and grip the line fitting knob with another hand, rotate the line fitting knob clockwise (the same direction shown on the bump knob). The line will wind onto the spool automatically (see Fig. J3).
- 5) Continue to rotate the line fitting knob until the line is at the desired length (see Fig. J4).

NOTE: Do not over-rotate the line fitting knob, or the extended line will be too short.

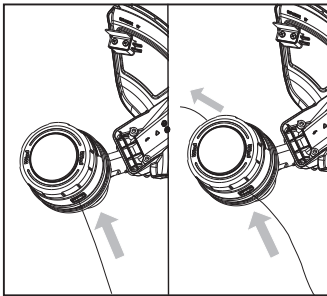

J1

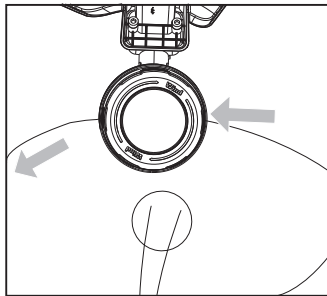

J2

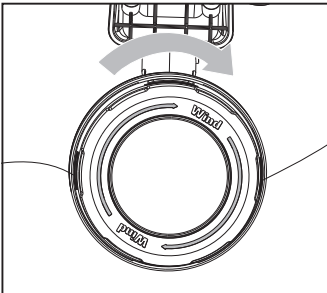

J3

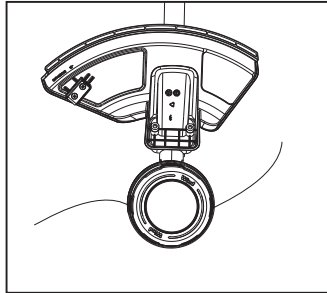

J4



WARNING: Your trimmer is designed to use only line with a maximum diameter of 0.095" (0.24 cm).



WARNING: Always remove the battery pack from your trimmer after use.

model no. 060-1913-8 | contact us: 1.866.523.5218

MAINTENANCE

Always check the product prior to being used for any damage.

After use, disconnect the battery from the tool and check for damage.

Your power tool requires no additional lubrication or maintenance. There are no user serviceable parts in your power tool. Never use water or chemical cleaners to clean your power tool. Wipe clean with a dry cloth. Always store your trimmer in a dry room. Keep the motor ventilation slots clean. Keep all working controls free of dust.

1. Replacing the spool holder or spool

If you find that the automatic line fitting system is damaged (i.e. the line cannot wind itself automatically), you should replace the spool holder or the spool. Follow the instructions below to change the spool holder or the spool.

- 1) Depress both spool holder release knobs (20) at the edge side of the spool holder (see Fig. K1).
- 2) Pull the whole spool holder with spool out from the trimmer head (see Fig. K2).
- 3) Take the spool (a) out from the spool holder (11). Check the spool or the spool holder for damage and change for new ones (see Fig. K3).

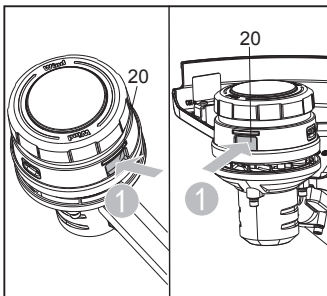

K1

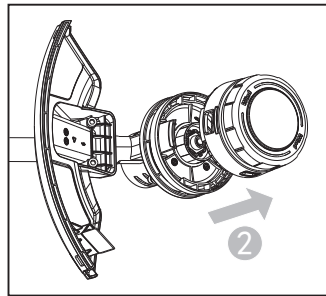

K2

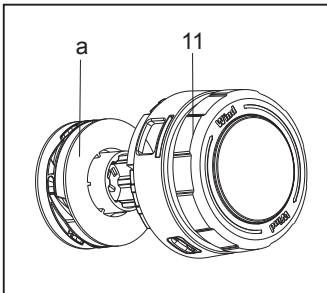

K3

STORING YOUR GRASS TRIMMER

Store in a dry place where the trimmer and battery can be protected from damage.

For Battery tools

The ambient temperature range for the use and storage of tool and battery is 32°F to 113°F (0°C to 45°C).

The recommended ambient temperature range for the charging system during charging is 32°F to 104°F (0°C to 40°C).

It is recommended that the battery be stored indoors for the winter months.

model no. 060-1913-8 | contact us: 1.866.523.5218

The following table gives problems and actions that you can perform if your machine does not operate correctly. Warning: Switch the trimmer off and remove the battery prior to any troubleshooting.

Problem	Possible Cause	Corrective Action
Trimmer fails to operate.	Battery discharged.	Recharge battery; also see the content in charger manual.
	Battery too hot/cold.	Allow to cool/warm.
	Motor is broken. Internal wiring of machine damaged.	Contact Yardworks [®] at 1.866.523.5218. Contact Yardworks [®] at 1.866.523.5218.
Trimmer runs intermittently.	Motor is broken.	Contact Service Agent.
	Battery not fully charged.	Recharge battery.
	On/Off switch defective.	Contact Yardworks [®] at 1.866.523.5218.
Excessive vibrations /noise.	Machine defective.	Contact Yardworks [®] at 1.866.523.5218.
	Line spool is not wound well.	Rewind the line. See "To replace the line on the spool".
Cutting time per battery charge too short.	Battery has not been used for long period or only charged for short term.	Fully charge battery; also see the content in charger manual.
	Grass too high.	Cut in stages.
	Battery defective.	Replace the battery.
Machine does not cut.	Line broken.	Replace the line.
	Battery not fully charged.	Recharge battery; also see the content in charger manual.
	Motor is broken (speed is too low).	Contact Yardworks [®] at 1.866.523.5218.
	Grass entangled around cutting head.	Remove grass.
Continuous lighting of the battery charge indicator/ battery not charging.	Battery not (properly) inserted.	Properly insert battery into battery charger.
	Battery contacts contaminated.	Clean the battery contacts or replace the battery.
	Battery defective.	Replace the battery.
Battery charge indicator does not light up.	Plug of battery charger not plugged in (properly).	Insert mains plug (fully) into the socket outlet.
	Outlet or mains cable defective.	Check the mains voltage.
	Battery charger defective.	Replace the battery charger.

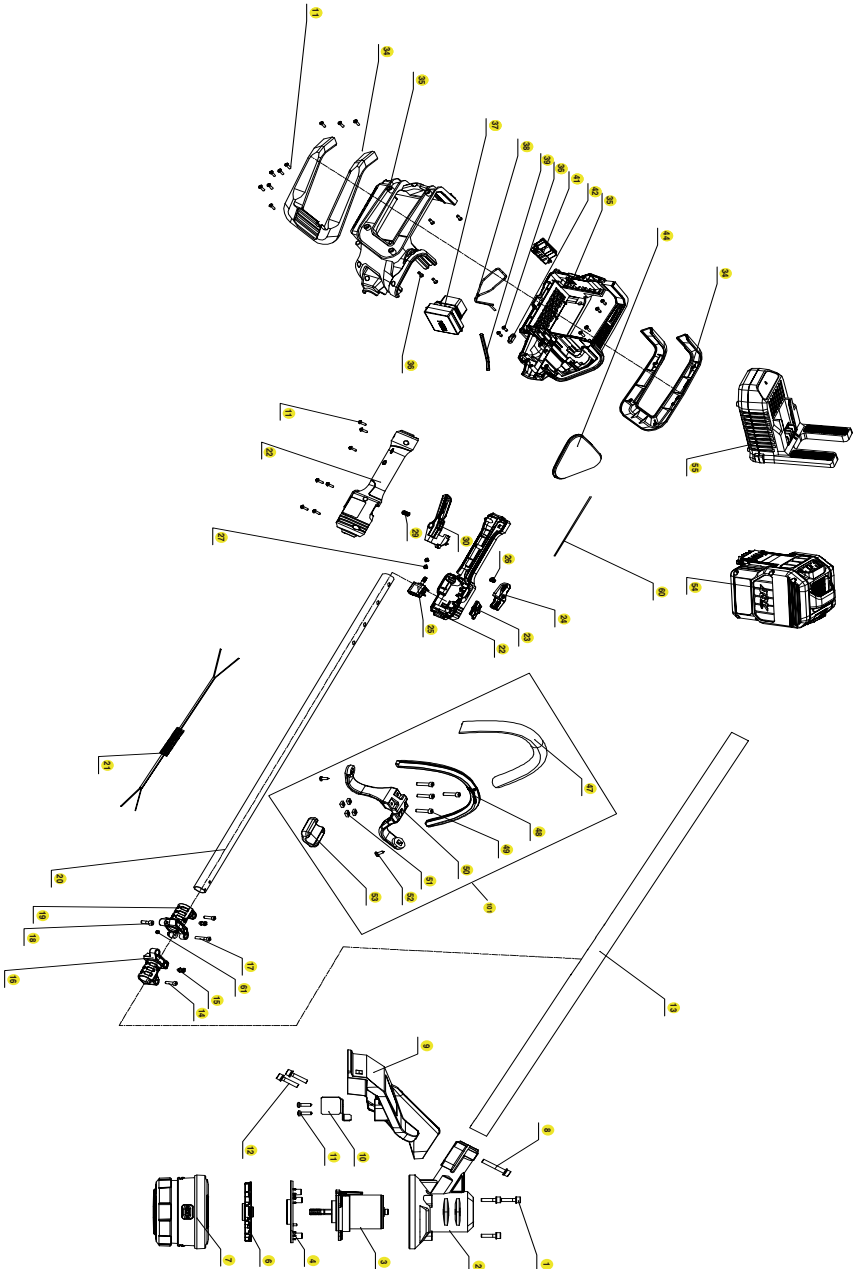

model no. 060-1913-8 | contact us: 1.866.523.5218

No.	Part Description	Quantity
1	Self Tapping Screw M5*25	3
2	Housing	1
3	Motor	1
4	Motor Mounting Plate	1
6	Fan	1
7	Cutting Head	1
8	Screw M5*30	1
9	Shield	1
10	Blade	1
11	Self Tapping Screw ST3.9X16	18
12	Self Tapping Screw M5X25	2
13	Aluminium Tube	1
14	Screw M5*20	2
15	Screw washer assembly M4X10	2
16	Connector II	1
17	Screw	1
18	Screw M6*20	1
19	Connector I	1
20	Aluminium Tube	1
21	Coiled Cable	1
22	Left/Right Handle	1
23	Push Button	1
24	Lock Knob	1
25	Switch	1
26	Compression spring	1
27	Self Tapping Screw ST3X6.5	2
29	Spring	1
30	Trigger	1
34	Left/Right Decorative Cover	1
35	Left/Right battery support	1
36	Self tapping screw ST3.9x13	10
37	Protect Control Board	1
38	Torsional Spring	1
39	Spanner	1
41	Terminal	1
42	Cord Clamp	1
44	Cover	1
47	Tube	1
48	Auxiliary Handle	1
49	Screw M6x30	4
50	Steady Handle Supper	1
51	Nut M6	4
52	Self Tapping Screw ST4.8X22	2
53	Steady Handle Cover	1
54	Battery Pack (Li-ion,2.0Ah,48V) ABP4820SH	1
55	Charger (120V,48V,110W) ACG4820HU	1
60	Inner wiring	1
61	Lock nut	1
101	Auxiliary Handle Assembly	1

FIVE-YEAR LIMITED WARRANTY

For five (5) years from the date of purchase within Canada, YARDWORKS CANADA will, at its option, repair or replace for the original purchaser, free of charge, any part or parts found to be defective in material or workmanship (excludes battery).

For THREE (3) years from the date of purchase within Canada, YARDWORKS CANADA will, at its option, repair or replace for the original purchaser, free of charge, any battery found to be defective in material or workmanship.

THIS WARRANTY DOES NOT COVER

1. Any part that has become inoperative due to misuse, commercial use, abuse, neglect, accident, improper maintenance, or alteration;
2. The unit, if it has not been operated and/or maintained in accordance with the owner's manual;
3. Normal wear, except as noted below;
4. Routine maintenance items such as lubricants, blade sharpening; or
5. Normal deterioration of the exterior finish due to use or exposure.

FULL ONE YEAR (365) DAYS WARRANTY ON NORMAL WEAR PARTS

Normal wear parts are defined as blade adaptors, blades, grass bags and tires. These parts are warranted to the original purchaser to be free from defects in material and workmanship for a period of three hundred and sixty-five (365) days from the date of retail purchase.

Made in China. Imported by Yardworks Canada
Toronto, Canada M4S 2B8

HOW TO OBTAIN SERVICE

Warranty service is available by calling the toll-free helpline at 1.866.523.5218. The factory will not accept the return of a complete unit unless prior written permission has been extended by YARDWORKS CANADA.

TRANSPORTATION CHARGES

Transportation charges for the movement of any power equipment unit or attachment are the responsibility of the purchaser. The purchaser must pay transportation charges for any part submitted for replacement under this warranty unless such return is requested in writing by YARDWORKS CANADA.

OTHER WARRANTIES

All other warranties, express or implied, including any implied warranty of merchantability is limited in its duration to that set forth in this express limited warranty. The provisions as set forth in this warranty provide the sole and exclusive remedy of YARDWORKS CANADA obligations arising from the sale of its products.



Always remove or disconnect the battery pack before adjusting, cleaning, servicing or transporting your appliance.



model no. 060-1913-8 | contact us: 1.866.523.5218

FCC Part 15

Supplier's Declaration of Conformity
Product Description: 48V 2.0 A Charger
Model Number: 060-1990-2
Trade Name: Yardworks®

This device complies with part 15 of the FCC Rules.

Operation is subject to the following two conditions:

- (1) This device may not cause harmful interference, and
- (2) This device must accept any interference received, including interference that may cause undesired operation.

Responsible Party:
Positec USA, Inc.
PO Box 681298, Charlotte, NC 28216
Tel: 1.866.523.5218
Fax: (704) 599-6390

